



FIXE

P05

(EN) Pulley with fixed side plates

(FR) Poulie à flasque fixe

(DE) Seilrolle mit fixen Seitenplatten

(IT) Carrucola a flange fissa

(ES) Polea con placa fija

CE 0197

EN 12278



90 g

individually tested

Made in France
3 year guarantee

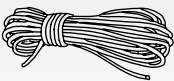

Ø ≤ 13 mm

PRICE

Batch n°
N° de série
Seriennummer
N° di serie
N° de serie

00 000 A

Year of manufacture
Année de fabrication
Herstellungsjahr
Anno di fabbricazione
Año de fabricación

Production date
Jour de fabrication
Tag der Herstellung
Giorno di fabbricazione
Día de fabricación

Control
Contrôle
Kontrolle
Controllo
Control

Ø ≤ 13 mm

Maximum rope diameter
Diamètre maxi de la corde
Maximaler Seildurchmesser
Diámetro massimo della corda
Diámetro máximo de la cuerda

CE 0197

Body controlling the manufacturing of this PPE

Organisme contrôlant la fabrication de cet EPI
Organismus der die Herstellung dieses PSA kontrolliert
Organismo che controlla la fabbricazione di questo DPI
Organismo controlador de la fabricación de este EPI

Notified body intervening for the CE standard examination
Organisme notifié intervenant pour l'examen CE de type
Zertifikationsorganismus für CE Typen Überprüfung
Ente riconosciuto che interviene per l'esame CE del tipo
Organismo notificado que interviene en el examen CE de tipo

APAVE Lyonnaise BP 3, 69811 Tassin Cedex, France, n°0082



F 38920 Crolles
www.petzl.com

Copyright Petzl
Printed in France ISO 9001

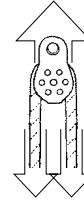

Breaking load
Charge de rupture
Bruchlast
Carico di rottura
Carga de rotura

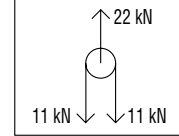

Working load limit
Valeur d'utilisation maxi
Maximale Gebrauchslast
Valore d'utilizzo massimo
Valor de utilización máximo

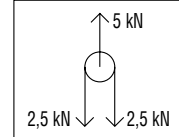
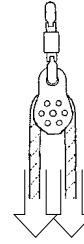

Working load limit with crossed carabiners
Valeur maxi d'utilisation avec mousquetons croisés
Maximale Gebrauchslast bei gekreuztem Karabiner
Valore d'utilizzo massimo con moschettoni incrociati
Valor de utilización máximo con mosquetones cruzados

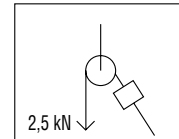
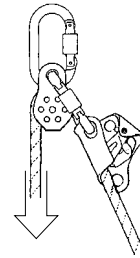

M70
+ P05
+ M70
+ B18 (B17)

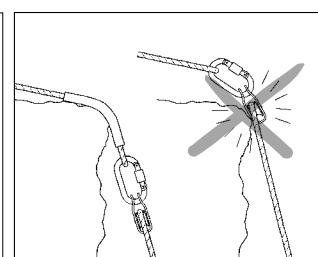
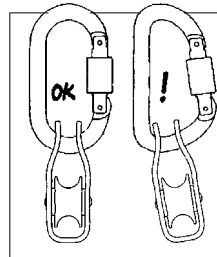

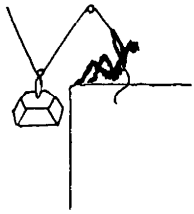

F maxi = person's weight
poids de la personne
 Gewicht der Person
peso della persona
 peso de la persona

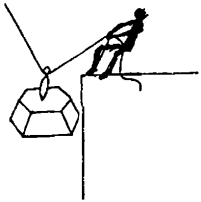

F maxi = muscular effort (> person's weight)
force musculaire (> poids de la personne)
 muskuläre Kraft (> Gewicht der Person)
forza muscolare (> peso della persona)
 fuerza muscular (> peso de la persona)

Simple pulley
Poulie simple
 Einfache Seilrolle
Carrucola semplice
 Polea simple

Pulley with ratchet
Poulie avec anti-retour
 Seilrolle mit Rücklaufsperr
Carrucola con anti-ritorno
 Polea anti-retorno

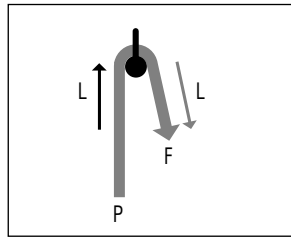
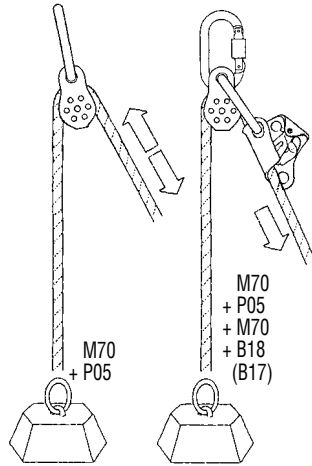

Simple hauling system
Mouflage simple
 Einfacher Flaschenzug
Recupero semplice
 Polipasto simple

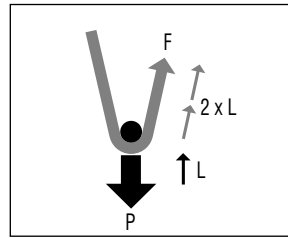
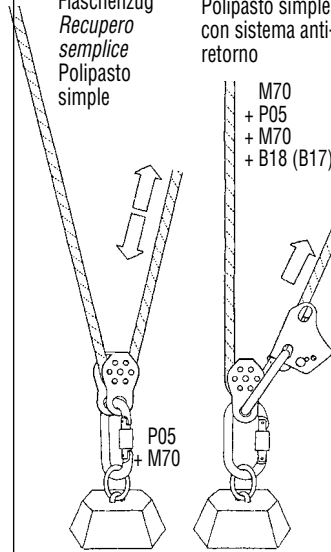

Simple hauling system with anti-slip lock
Mouflage simple avec anti-retour
 Einfacher Flaschenzug mit Rücklaufsperr
Mezzo paranco
 Polipasto simple con sistema anti-retorno

M70
 + P05
 + M70
 + B18 (B17)

Anti-slip hauling system with two ascenders
Mouflage anti-retour avec deux bloqueurs
 Flaschenzug mit Rücklaufsperr mit zwei Seilklemmen
Paranco completo
 Polipasto anti-retorno con dos bloqueadores

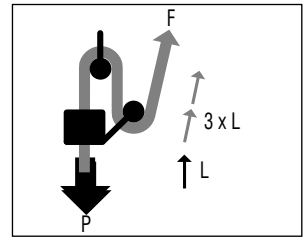
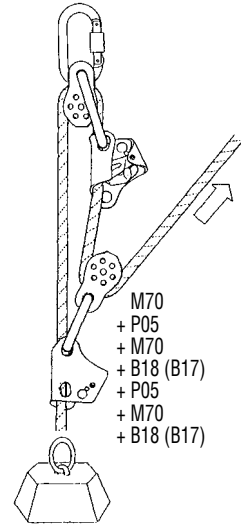

Theoretical force
Force théorique
 Theoretische Kraft
Forza teorica
 Fuerza teórica

$$F = P$$

$$F = 0,5 P$$

$$F = 0,33 P$$

Actual force
Force réelle
 Reelle Kraft
Forza reale
 Fuerza real



$$F = 1,4 P$$

$$F = 0,58 P$$

$$F = 0,45 P$$



$$F = 2 P$$

$$F = 0,66 P$$

$$F = 0,57 P$$